



LS4, LS4_K, LS4_H series

Light Curtains

Type 4 according to IEC 61496-1 and IEC 61496-2



Light Curtains
Type 4

features

- Compact housing (28 x 30 mm) and no dead zone on cap side
- Resolution 14 mm for finger protection, 20, 30, 40 mm for hand protection, 50, 90 mm for presence control and 2, 3, 4 beams for body protection/access control
- Controlled distance up to: 3, 4, 6, 10, 12 m
- Base, Standard versions and Master, Slave version to connect up to 3 sets in cascade configuration
- Selectable Automatic/Manual Restart and EDM integrated functions (Standard models)
- Selectable controlled distance
- IP69K protection models (LS4_K) and models with integrated heating system to reach -25°C operating temperature (LS4_H)
- Standard M12 da 5 and 8 poles connectors

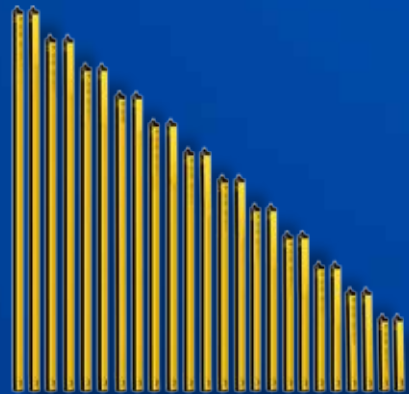

web contents

- Application notes
- Photos
- Catalogue / Manuals



code description

LS4 ER / 30 - 015

series	LS4	Type 4 safety light curtains 28 x 30 mm compact housing
E/R	ER	Emitter / Receiver couple
beams	14	Light grid, 14 mm resolution, finger protection
	20	Light grid, 20 mm resolution, hand protection
	30	Light grid, 30 mm resolution, hand protection
	40	Light grid, 40 mm resolution, hand protection
	50	Light grid, 50 mm resolution, presence control
	90	Light grid, 90 mm resolution, presence control
	0A	2 beams; body protection, 500 mm resolution
	0B	3 beams; body protection, 400 mm resolution
	0C	4 beams; body protection, 300 mm resolution
area	015-180	Protected height from 150 to 1,800 mm (light grids)
	050-090	Protected height 500, 800, 900 mm (multiple light beams)
model		Standard model with selectable MANUAL/AUTOMATIC Restart and EDM functions
	B	Base model with integrated AUTOMATIC Restart
	M	Master Model with selectable functions
	S	Intermediate Slave model
	F	Final Slave model
distance		Controlled distance
	L	Extended range
models		IP65 and IP67 protection, 10° ... 55 °C operating temperature
	K	Models in transparent cylindrical housing, IP69K, suitable for applications in the food industry. Resistance to washing with water at 100 bar, 80 ° C Housing in PMMA, caps in POM C with silicone seals. Brackets in stainless steel AISI 316L. Operating temperature -10 ... 55 ° C
	H	Models in transparent cylindrical casing, IP69K protection, thermostated, suitable for applications in the food industry. Resistance to washing with water at 100 bar, 80 ° C Housing in PMMA, POM C caps and silicone seals. Brackets in stainless steel AISI 316L. Operating temperature -25 ... 55 ° C

LS4; LS4_K;
LS4_H

available models

14 mm resolution; 0...3 / 1...6 m controlled distance

protected height (mm)	n° of beams	response time (ms)	series
144	15	4	LS4ER/14-015B
			LS4ER/14-015
			LS4ER/14-015F
294	30	5.5	LS4ER/14-030B
			LS4ER/14-030
			LS4ER/14-030M
			LS4ER/14-030F
			LS4ER/14-030S
			LS4ER/14-045B
444	45	7.5	LS4ER/14-045
			LS4ER/14-045M
			LS4ER/14-045F
			LS4ER/14-045S
			LS4ER/14-060B
			LS4ER/14-060
594	60	9	LS4ER/14-060M
			LS4ER/14-060F
			LS4ER/14-060S
			LS4ER/14-075B
			LS4ER/14-075
			LS4ER/14-075M
744	75	11	LS4ER/14-075F
			LS4ER/14-075S
			LS4ER/14-090B
			LS4ER/14-090
			LS4ER/14-090M
			LS4ER/14-090F
894	90	13	LS4ER/14-090S
			LS4ER/14-105B
			LS4ER/14-105
			LS4ER/14-105M
			LS4ER/14-105F
			LS4ER/14-105S
1,044	105	14.5	LS4ER/14-120B
			LS4ER/14-120
			LS4ER/14-120M
			LS4ER/14-120F
			LS4ER/14-120S
			LS4ER/14-135B
1,344	135	18	LS4ER/14-135
			LS4ER/14-135M
			LS4ER/14-135F
			LS4ER/14-135S
			LS4ER/14-150B
			LS4ER/14-150
1,494	150	20	LS4ER/14-150M
			LS4ER/14-150F
			LS4ER/14-150S

available models

20 mm resolution; 0...10 / 3...20 m controlled distance

protected height (mm)	n° of beams	response time (ms)	series
144	15	4	LS4ER/20-015BL
			LS4ER/20-015BL
294	30	5.5	LS4ER/20-030BL
			LS4ER/20-030L
444	45	7.5	LS4ER/20-045BL
			LS4ER/20-045L
594	60	9	LS4ER/20-060BL
			LS4ER/20-060L
744	75	11	LS4ER/20-075BL
			LS4ER/20-075L
894	90	13	LS4ER/20-090BL
			LS4ER/20-090L
1,044	105	14.5	LS4ER/20-105BL
			LS4ER/20-105L
1,194	120	16.5	LS4ER/120BL
			LS4ER/120L
1,344	135	18	LS4ER/135BL
			LS4ER/135L
1,494	150	20	LS4ER/150BL
			LS4ER/150L

available models

30 mm resolution; 0...4 / 0...12 m controlled distance

protected height (mm)	n° of beams	response time (ms)	series
160	8	4	LS4ER/30-015B
			LS4ER/30-015
			LS4ER/30-015F
310	16	5.5	LS4ER/30-030B
			LS4ER/30-030
			LS4ER/30-030M
			LS4ER/30-030F
			LS4ER/30-030S
			LS4ER/30-045B
460	23	7.5	LS4ER/30-045
			LS4ER/30-045M
			LS4ER/30-045F
			LS4ER/30-045S
			LS4ER/30-060B
			LS4ER/30-060
610	31	9	LS4ER/30-060M
			LS4ER/30-060F
			LS4ER/30-060S
			LS4ER/30-075B
			LS4ER/30-075
			LS4ER/30-075M
760	38	10.5	LS4ER/30-075F
			LS4ER/30-075S
			LS4ER/30-090B
			LS4ER/30-090
			LS4ER/30-090M
			LS4ER/30-090F
910	46	12.5	LS4ER/30-090S
			LS4ER/30-105B
			LS4ER/30-105
			LS4ER/30-105M
			LS4ER/30-105F
			LS4ER/30-105S
1,060	53	14	LS4ER/30-120B
			LS4ER/30-120
			LS4ER/30-120M
			LS4ER/30-120F
			LS4ER/30-120S
			LS4ER/30-135B
1,360	68	17	LS4ER/30-135
			LS4ER/30-135M
			LS4ER/30-135F
			LS4ER/30-135S
			LS4ER/30-150B
			LS4ER/30-150
1,510	76	19	LS4ER/30-150M
			LS4ER/30-150F
			LS4ER/30-150S
			LS4ER/30-165
1,660	83	20.5	LS4ER/30-165
1,810	91	22	LS4ER/30-180

available models

30 mm resolution; 0...10 / 0...20 m controlled distance

protected height (mm)	n° of beams	response time (ms)	series
160	8	3	LS4ER/30-015BL
			LS4ER/30-015L
310	16	4	LS4ER/30-030BL
			LS4ER/30-030L
460	23	5	LS4ER/30-045BL
			LS4ER/30-045L
610	31	6	LS4ER/30-060BL
			LS4ER/30-060L
760	38	6.5	LS4ER/30-075BL
			LS4ER/30-075L
910	46	7.5	LS4ER/30-090BL
			LS4ER/30-090L
1,060	53	8.5	LS4ER/30-105BL
			LS4ER/30-105L
1,210	61	9.5	LS4ER/30-120BL
			LS4ER/30-120L
1,360	68	10	LS4ER/30-135BL
			LS4ER/30-135L
1,510	76	11	LS4ER/30-150BL
			LS4ER/30-150L
1,660	83	12	LS4ER/30-165L
1,810	91	13	LS4ER/30-180L

available models

40 mm; 0...4 / 0...12 m controlled distance

protected height (mm)	n° of beams	response time (ms)	series
160	6	3.5	LS4ER/40-015B
			LS4ER/40-015
			LS4ER/40-015M
			LS4ER/40-015F
			LS4ER/40-015S
310	11	4.5	LS4ER/40-030B
			LS4ER/40-030
			LS4ER/40-030M
			LS4ER/40-030F
			LS4ER/40-030S
460	16	5.5	LS4ER/40-045B
			LS4ER/40-045
			LS4ER/40-045M
			LS4ER/40-045F
			LS4ER/40-045S

available models

40 mm resolution; 0...4 / 0...12 m controlled distance

protected height (mm)	n° of beams	response time (ms)	series
610	21	7	LS4ER/40-060B
			LS4ER/40-060
			LS4ER/40-060M
			LS4ER/40-060F
			LS4ER/40-060S
760	26	8	LS4ER/40-075B
			LS4ER/40-075
			LS4ER/40-075M
			LS4ER/40-075F
			LS4ER/40-075S
910	31	9	LS4ER/40-090B
			LS4ER/40-090
			LS4ER/40-090M
			LS4ER/40-090F
			LS4ER/40-090S
1,060	36	10	LS4ER/40-105B
			LS4ER/40-105
			LS4ER/40-105M
			LS4ER/40-105F
			LS4ER/40-105S
1,210	41	11	LS4ER/40-120B
			LS4ER/40-120
			LS4ER/40-120M
			LS4ER/40-120F
			LS4ER/40-120S
1,360	46	12.5	LS4ER/40-135B
			LS4ER/40-135
			LS4ER/40-135M
			LS4ER/40-135F
			LS4ER/40-135S
1,510	51	13.5	LS4ER/40-150B
			LS4ER/40-150
			LS4ER/40-150M
			LS4ER/40-150F
			LS4ER/40-150S

available models

40 mm resolution; 0...10 / 3...20 m controlled distance

protected height (mm)	n° of beams	response time (ms)	series
160	6	3	LS4ER/40-015BL
			LS4ER/40-015L
310	11	3.5	LS4ER/40-030BL
			LS4ER/40-030L
460	16	4	LS4ER/40-045BL
			LS4ER/40-045L
610	21	4.5	LS4ER/40-060BL
			LS4ER/40-060L
760	26	5	LS4ER/40-075BL
			LS4ER/40-075L
910	31	6	LS4ER/40-090BL
			LS4ER/40-090L
1,060	36	6.5	LS4ER/40-105BL
			LS4ER/40-105L
1,210	41	7	LS4ER/40-120BL
			LS4ER/40-120L
1,360	46	7.5	LS4ER/40-135BL
			LS4ER/40-135L
1,510	51	8	LS4ER/40-150BL
			LS4ER/40-150L

available models

50 mm resolution; 0...4 / 0...12 m controlled distance

protected height (mm)	n° of beams	response time (ms)	series
160	4	3	LS4ER/50-015B
			LS4ER/50-015
			LS4ER/50-015M
			LS4ER/50-015F
			LS4ER/50-015S
310	8	4	LS4ER/50-030B
			LS4ER/50-030
			LS4ER/50-030M
			LS4ER/50-030F
			LS4ER/50-030S

available models

50 mm resolution; 0...4 / 0...12 m controlled distance

protected height (mm)	n° of beams	response time (ms)	series
460	12	4.5	LS4ER/50-045B
			LS4ER/50-045
			LS4ER/50-045M
			LS4ER/50-045F
			LS4ER/50-045S
610	16	5.5	LS4ER/50-060B
			LS4ER/50-060
			LS4ER/50-060M
			LS4ER/50-060F
			LS4ER/50-060S
760	20	6.5	LS4ER/50-075B
			LS4ER/50-075
			LS4ER/50-075M
			LS4ER/50-075F
			LS4ER/50-075S
910	24	7.5	LS4ER/50-090B
			LS4ER/50-090
			LS4ER/50-090M
			LS4ER/50-090F
			LS4ER/50-090S
1,060	28	8.5	LS4ER/50-105B
			LS4ER/50-105
			LS4ER/50-105M
			LS4ER/50-105F
			LS4ER/50-105S
1,210	32	9.5	LS4ER/50-120B
			LS4ER/50-120
			LS4ER/50-120M
			LS4ER/50-120F
			LS4ER/50-120S
1,360	36	10	LS4ER/50-135B
			LS4ER/50-135
			LS4ER/50-135M
			LS4ER/50-135F
			LS4ER/50-135S
1,510	40	11	LS4ER/50-150B
			LS4ER/50-150
			LS4ER/50-150M
			LS4ER/50-150F
			LS4ER/50-150S

available models

50 mm resolution; 0...10 / 3...20 m controlled distance

protected height (mm)	n° of beams	response time (ms)	series
160	4	2.5	LS4ER/50-015BL
			LS4ER/50-015L
310	8	3	LS4ER/50-030BL
			LS4ER/50-030L
460	12	3.5	LS4ER/50-045BL
			LS4ER/50-045L
610	16	4	LS4ER/50-060BL
			LS4ER/50-060L
760	20	4.5	LS4ER/50-075BL
			LS4ER/50-075L
910	24	5	LS4ER/50-090BL
			LS4ER/50-090L
1,060	28	5.5	LS4ER/50-105BL
			LS4ER/50-105L
1,210	32	6	LS4ER/50-120BL
			LS4ER/50-120L
1,360	36	6.5	LS4ER/50-135BL
			LS4ER/50-135L
1,510	40	7	LS4ER/50-150BL
			LS4ER/50-150L

available models

90 mm resolution; 0...4 / 0...12 m controlled distance

protected height (mm)	n° of beams	response time (ms)	series
310	4	3	LS4ER/90-030B
			LS4ER/90-030
			LS4ER/90-030M
			LS4ER/90-030F
			LS4ER/90-030S
460	6	3.5	LS4ER/90-045B
			LS4ER/90-045
			LS4ER/90-045M
			LS4ER/90-045F
			LS4ER/90-045S
610	8	4	LS4ER/90-060B
			LS4ER/90-060
			LS4ER/90-060M
			LS4ER/90-060F
			LS4ER/90-060S

available models

90 mm resolution; 0...4 / 0...12 m controlled distance

protected height (mm)	n° of beams	response time (ms)	series
760	10	4.5	LS4ER/90-075B
			LS4ER/90-075
			LS4ER/90-075M
			LS4ER/90-075F
			LS4ER/90-075S
910	12	5	LS4ER/90-090B
			LS4ER/90-090
			LS4ER/90-090M
			LS4ER/90-090F
			LS4ER/90-090S
1,060	14	5.5	LS4ER/90-105B
			LS4ER/90-105
			LS4ER/90-105M
			LS4ER/90-105F
			LS4ER/90-105S
1,210	16	5.5	LS4ER/90-120B
			LS4ER/90-120
			LS4ER/90-120M
			LS4ER/90-120F
			LS4ER/90-120S
1,360	18	6	LS4ER/90-135B
			LS4ER/90-135
			LS4ER/90-135M
			LS4ER/90-135F
			LS4ER/90-135S
1,510	20	6.5	LS4ER/90-150B
			LS4ER/90-150
			LS4ER/90-150M
			LS4ER/90-150F
			LS4ER/90-150S

available models

90 mm resolution; 0...10 / 3...20 m controlled distance

protected height (mm)	n° of beams	response time (ms)	series
310	4	2.5	LS4ER/90-030BL
			LS4ER/90-030L
460	6	3	LS4ER/90-045BL
			LS4ER/90-045L
610	8	3	LS4ER/90-060BL
			LS4ER/90-060L
760	10	3.5	LS4ER/90-075BL
			LS4ER/90-075L
910	12	3.5	LS4ER/90-090BL
			LS4ER/90-090L
1,060	14	3.5	LS4ER/90-105BL
			LS4ER/90-105L
1,210	16	4	LS4ER/90-120BL
			LS4ER/90-120L
1,360	18	4	LS4ER/90-135BL
			LS4ER/90-135L
1,510	20	4.5	LS4ER/90-150BL
			LS4ER/90-150L

available models

resolution 2,3,4 beams; 0...4 / 0...12 m controlled distance

protected height (mm)	n° of beams	distance betw. beams (mm)	response time (ms)	series
510	2	500	2.5	LS4ER/0A-050B
				LS4ER/0A-050
				LS4ER/0A-050M
				LS4ER/0A-050F
				LS4ER/0A-050S
810	3	800	3	LS4ER/0B-080B
				LS4ER/0B-080
				LS4ER/0B-080M
				LS4ER/0B-080F
				LS4ER/0B-080S
910	4	900	3	LS4ER/0C-090B
				LS4ER/0C-090
				LS4ER/0C-090M
				LS4ER/0C-090F
				LS4ER/0C-090S

available models

resolution 2,3,4 beams; 0...10 / 3...20 m controlled distance

protected height (mm)	n° of beams	distance betw. beams (mm)	response time (ms)	series
510	2	500	2.5	LS4ER/0A-050BL
				LS4ER/0A-050L
810	3	800	2.5	LS4ER/0B-080BL
				LS4ER/0B-080L
910	4	900	2.5	LS4ER/0C-090BL
				LS4ER/0C-090L

available models

14 mm resolution; 0...3 / 1...5 m controlled distance

protected height (mm)	n° of beams	response time (ms)	series
144	15	4	LS4ER/14-015K
294	30	5.5	LS4ER/14-030K
444	45	7.5	LS4ER/14-045K
594	60	9	LS4ER/14-060K
744	75	11	LS4ER/14-075K
894	90	13	LS4ER/14-090K
1,044	105	14.5	LS4ER/14-105K
1,194	120	16.5	LS4ER/14-120K
1,344	135	18	LS4ER/14-135K
1,494	150	20	LS4ER/14-150K

available models

30 mm resolution; 0...8 / 3...17 m controlled distance

protected height (mm)	n° of beams	response time (ms)	series
160	8	3	LS4ER/30-015LK
310	16	4	LS4ER/30-030LK
460	23	5	LS4ER/30-045LK
610	31	6	LS4ER/30-060LK
760	38	6.5	LS4ER/30-075LK
910	46	7.5	LS4ER/30-090LK
1,060	53	8.5	LS4ER/30-105LK
1,210	61	9.5	LS4ER/30-120LK
1,360	68	10	LS4ER/30-135LK
1,510	76	11	LS4ER/30-150LK

available models

14 mm resolution; 0...3 / 1...5 m controlled distance

protected height (mm)	n° of beams	response time (ms)	series
144	15	4	LS4ER/14-015H
294	30	5.5	LS4ER/14-030H
444	45	7.5	LS4ER/14-045H
594	60	9	LS4ER/14-060H
744	75	11	LS4ER/14-075H
894	90	13	LS4ER/14-090H
1,044	105	14.5	LS4ER/14-105H
1,194	120	16.5	LS4ER/14-120H
1,344	135	18	LS4ER/14-135H
1,494	150	20	LS4ER/14-150H

available models

30 mm resolution; 0...8 / 3...17 m controlled distance

protected height (mm)	n° of beams	response time (ms)	serie
160	8	3	LS4ER/30-015LH
310	16	4	LS4ER/30-030LH
460	23	5	LS4ER/30-045LH
610	31	6	LS4ER/30-060LH
760	38	6.5	LS4ER/30-075LH
910	46	7.5	LS4ER/30-090LH
1,060	53	8.5	LS4ER/30-105LH
1,210	61	9.5	LS4ER/30-120LH
1,360	68	10	LS4ER/30-135LH
1,510	76	11	LS4ER/30-150LH

available models

resolution 2,3,4 beams; 0...10 / 3...20 m controlled distance

protected height (mm)	n° of beams	response time (ms)	series
510	2	2.5	LS4ER/0A-050LK
810	3		LS4ER/0B-080LK
910	4		LS4ER/0C-090LK

available models

resolution 2,3,4 beams; 0...10 / 3...20 m controlled distance

protected height (mm)	n° of beams	response time (ms)	series
510	2	2.5	LS4ER/0A-050LH
810	3		LS4ER/0B-080LH
910	4		LS4ER/0C-090LH

technical specifications

Light Curtains
Type 4

	LS4ER/**-*** _	
		
operating voltage	19.2...28.8	PELV power supplier according to EN 60204-1 Cap. 6.4
power consumption, Receiver	2 W	no load
power consumption, Emitter	1 W	
power consumption, heater	2...10 W	H models, IP69K with heater
output type	2 x PNP	OSSD safety outputs
output current	400 mA	higher values are considered overload
equivalent resistive load	60 Ω	lower values are considered short circuit
capacitive load	0.82 µF	lower values may be considered short circuit
recovery time	2 s	
response time	2.5...20 ms	
effective aperture angle	≤ ± 2.5°	IEC 61496-1
artificial light rejection	according to IEC 61496-2	according to the reported standards
ambient light rejection	according to IEC 61496-2	
IP mechanical protection (standard models)	IP65 e IP67	without any additional precaution the device can't be used for outdoor applications
IP mechanical protection (special models)	IP65, IP67 and IP69K	external transparent tube resistant against 100 bar water jets
operating temperature	-10...+55°C	no condensation
operating temperature, K models	-10...+55°C	no condensation, models without internal heater
operating temperature, H models	-25...+55°C	models with internal heater
storage temperature	-25...+70°C	to be respected also during transportation
humidity	95%	no condensation
vibrations	according to IEC 61496-1	according to the reported standards
shocks	according to IEC 61496-1	
cable length (power supply/outputs)	100 m	cable section 0.34 mm ² (to respect max length)
max cable length for Master Slave interconnections	50 m	
dimension (IP67 models)	28 (front) x 30 mm	painting aluminium RAL 1012
tube (IP69K models)	ø 56 mm	
connectors models LS4ER/**-***B	Emitter 1 x M12, 5p, male Receiver 1 x M12, 5p male	nichel plated brass
connectors models LS4ER/**-***	Emitter 1 x M12, 5p, male Receiver 1 x M12, 8p male	
connectors models LS4ER/**-***M	Emitter 2 x M12, 5p, male Receiver 1 x M12, 8p male + 1 x M12, 5p male	
connectors models LS4ER/**-***S	Emitter 2 x M12, 5p, male Receiver 2 x M12, 5p male	
connectors models LS4ER/**-***F	Emitter 1 x M12, 5p, male Receiver 1 x M12, 5p male	
connectors models LS4ER/**-***K	Emitter 5 wires Receiver 8 wires	PVC sheath, ø 5.5 mm L 10 m, 0.34 mm ²
connectors models LS4ER/**-***H	Emitter 8 wires Receiver 10 wires	

LS4; LS4_K;
LS4_H

safety parameters

LS4ER/14-***_	015	030	045	060	075	090	105	120	135	150
height (mm)	160	310	460	610	760	910	1,060	1,210	1,360	1,510
number of beams	15	30	45	60	75	90	105	120	135	150
response time (ms)	4	5.5	7.5	9	11	13	14.5	16.5	18	20
response time Master + Slave (ms)	Ttot = [0.06 * (Nr Slave1 + Nr Master) + 0.9636] * 2 (Master + 1 Slave)									
response time Master + 2 Slave (ms)	Ttot = [0.06 * (Nr Slave1 + Nr Slave2 + Nr Master) + 1.0036] * 2 (Master + 2 Slave)									
Type ⁽¹⁾	4									
SIL ⁽²⁾	3									
SILCL ⁽³⁾	3									
PL ⁽⁴⁾	e									
PFHd	1.03E-08	1.27E-08	1.52E-08	1.75E-08	2.00E-08	2.24E-08	2.49E-08	2.73E-08	2.98E-08	3.22E-08
DCavg	95.40%	94.90%	94.50%	94.10%	93.80%	93.60%	93.30%	93.10%	92.90%	92.80%
MTTFd	100									
CFF	80%									

LS4ER/30-***_	015	030	045	060	075	090	105	120	135	150	165	180
height (mm)	160	310	460	610	760	910	1,060	1,210	1,360	1,510	1,660	1,810
number of beams	8	16	23	31	38	46	53	61	68	76	83	91
response time (ms)	4	5.5	7.5	9	10.5	12.5	14	15.5	17	19	20.5	22
response time Master + Slave (ms)	Ttot = [0.11 * (Nr Slave1 + Nr Master) + 0.9376] * 2 (Master + 1 Slave)											
response time Master + 2 Slave (ms)	Ttot = [0.11 * (Nr Slave1 + Nr Slave2 + Nr Master) + 1.0508] * 2 (Master + 2 Slave)											
Type ⁽¹⁾	4											
SIL ⁽²⁾	3											
SILCL ⁽³⁾	3											
PL ⁽⁴⁾	e											
PFHd	7.08E-09	8.20E-09	9.45E-09	1.06E-08	1.19E-08	1.30E-08	1.43E-08	1.54E-08	1.67E-08	1.78E-08	1.90E-08	2.02E-08
DCavg	96.60%	97.00%	97.20%	97.30%	97.40%	97.50%	97.70%	97.60%	97.70%	97.70%	97.70%	97.80%
MTTFd	100											
CFF	80%											

LS4ER/40-***_	015	030	045	060	075	090	105	120	135	150
height (mm)	160	310	460	610	760	910	1,060	1,210	1,360	1,510
number of beams	6	11	16	21	26	31	36	41	46	51
response time (ms)	3.5	4.5	5.5	7	8	9	10	11	12.5	13.5
response time Master + Slave (ms)	Ttot = [0.11 * (Nr Slave1 + Nr Master) + 0.9376] * 2 (Master + 1 Slave)									
response time Master + 2 Slave (ms)	Ttot = [0.11 * (Nr Slave1 + Nr Slave2 + Nr Master) + 1.0508] * 2 (Master + 2 Slave)									
Type ⁽¹⁾	4									
SIL ⁽²⁾	3									
SILCL ⁽³⁾	3									
PL ⁽⁴⁾	e									
PFHd	6.82E-09	7.76E-09	8.58E-09	9.52E-09	1.03E-08	1.13E-08	1.21E-08	1.30E-08	1.38E-08	1.48E-08
DCavg	96.40%	96.70%	96.90%	97.10%	97.20%	97.30%	97.40%	97.40%	97.50%	97.50%
MTTFd	100									
CFF	80%									

⁽¹⁾ref. CEI EN 61496-1; CEI EN 61496-2 ⁽²⁾ref. CEI EN 61508 ⁽³⁾ref. CEI EN 62061 + CEI EN 62061/EC2 ⁽⁴⁾ref. UNI EN ISO 13849-1

safety parameters

Light Curtains
Type 4

LS4ER/50-***_	015	030	045	060	075	090	105	120	135	150
height (mm)	160	310	460	610	760	910	1,060	1,210	1,360	1,510
number of beams	4	8	12	16	20	24	28	32	36	40
response time (ms)	3	4	4.5	5.5	6.5	7.5	8.5	9	10	11
response time Master + Slave (ms)	$T_{tot} = [0.11 * (Nr \text{ Slave1} + Nr \text{ Master}) + 0.9376] * 2$ (Master + 1 Slave)									
response time Master + 2 Slave (ms)	$T_{tot} = [0.11 * (Nr \text{ Slave1} + Nr \text{ Slave2} + Nr \text{ Master}) + 1.0508] * 2$ (Master + 2 Slave)									
Type ⁽¹⁾	4									
SIL ⁽²⁾	3									
SILCL ⁽³⁾	3									
PL ⁽⁴⁾	e									
PFHd	6.53E-09	7.16E-09	7.85E-09	8.48E-09	9.17E-08	9.80E-08	1.05E-08	1.11E-08	1.18E-08	1.24E-08
DCavg	96.50%	96.80%	96.90%	97.10%	97.20%	97.30%	97.40%	97.50%	97.50%	97.50%
MTTFd	100									
CFF	80%									

LS4ER/90-***_	030	045	060	075	090	105	120	135	150	
height (mm)	310	460	610	760	910	1,060	1,210	1,360	1,510	
number of beams	4	6	8	10	10	12	14	16	20	
response time (ms)	3	3.5	4	4.5	4.5	5	5.5	5.5	6.5	
response time Master + Slave (ms)	$T_{tot} = [0.11 * (Nr \text{ Slave1} + Nr \text{ Master}) + 0.9376] * 2$ (Master + 1 Slave)									
response time Master + 2 Slave (ms)	$T_{tot} = [0.11 * (Nr \text{ Slave1} + Nr \text{ Slave2} + Nr \text{ Master}) + 1.0508] * 2$ (Master + 2 Slave)									
Type ⁽¹⁾	4									
SIL ⁽²⁾	3									
SILCL ⁽³⁾	3									
PL ⁽⁴⁾	e									
PFHd	6.79E-09	7.16E-09	7.85E-09	8.48E-09	9.17E-08	9.80E-08	1.05E-08	1.11E-08	1.18E-08	
DCavg	96.50%	96.60%	96.70%	96.80%	96.90%	96.90%	97.00%	97.10%	97.10%	
MTTFd	100									
CFF	80%									

LS4ER/**-***_	0A-050	0B-080	0C-090
height (mm)	500	800	900
number of beams	2	3	4
response time (ms)	2,5	3	3
response time Master + Slave (ms)	$T_{tot} = [0.11 * (Nr \text{ Slave1} + Nr \text{ Master}) + 0.9376] * 2$ (Master + 1 Slave)		
response time Master + 2 Slave (ms)	$T_{tot} = [0.11 * (Nr \text{ Slave1} + Nr \text{ Slave2} + Nr \text{ Master}) + 1.0508] * 2$ (Master + 2 Slave)		
Type ⁽¹⁾	4		
SIL ⁽²⁾	3		
SILCL ⁽³⁾	3		
PL ⁽⁴⁾	e		
PFHd	6.89E-09	7.55E-08	8.21E-08
DCavg	96.20%	96.20%	96.10%
MTTFd	100		
CFF	80%		

⁽¹⁾ ref. CEI EN 61496-1; CEI EN 61496-2 ⁽²⁾ ref. CEI EN 61508 ⁽³⁾ ref. CEI EN 62061 + CEI EN 62061/EC2 ⁽⁴⁾ ref. UNI EN ISO 13849-1

LS4ER/20-***_L	015	030	045	060	075	090	105	120	135	150
height (mm)	160	310	460	610	760	910	1,060	1,210	1,360	1,510
number of beams	15	30	45	60	75	90	105	120	135	150
response time (ms)	4	5.5	7.5	9	11	13	14.5	16.5	18	20
response time Master + Slave (ms)	Ttot = [0.06 * (Nr Slave1 + Nr Master) + 0.9636] * 2 (Master + 1 Slave)									
response time Master + 2 Slave (ms)	Ttot = [0.06 * (Nr Slave1 + Nr Slave2 + Nr Master) + 1.0036] * 2 (Master + 2 Slave)									
Type ⁽¹⁾	4									
SIL ⁽²⁾	3									
SILCL ⁽³⁾	3									
PL ⁽⁴⁾	e									
PFHd	1.03E-08	1.27E-08	1.52E-08	1.75E-08	2.00E-08	2.24E-08	2.49E-08	2.73E-08	2.98E-08	3.22E-08
DCavg	95.40%	94.90%	94.50%	94.10%	93.80%	93.60%	93.30%	93.10%	92.90%	92.80%
MTTFd	100									
CFF	80%									

LS4ER/30-***_	015	030	045	060	075	090	105	120	135	150	165	180
height (mm)	160	310	460	610	760	910	1,060	1,210	1,360	1,510	1,660	1,810
number of beams	8	16	23	31	38	46	53	61	68	76	83	91
response time (ms)	3	4	5	6	6.5	7.5	8.5	9.5	10	11	12	13
response time Master + Slave (ms)	Ttot = [0.06 * (Nr Slave1 + Nr Master) + 0.9636] * 2 (Master + 1 Slave)											
response time Master + 2 Slave (ms)	Ttot = [0.06 * (Nr Slave1 + Nr Slave2 + Nr Master) + 1.0036] * 2 (Master + 2 Slave)											
Type ⁽¹⁾	4											
SIL ⁽²⁾	3											
SILCL ⁽³⁾	3											
PL ⁽⁴⁾	e											
PFHd	9.13E-09	1.04E-08	1.16E-08	1.28E-08	1.41E-08	1.53E-08	1.66E-08	1.78E-08	1.91E-08	2.03E-08	2.16E-09	2.29E-08
DCavg	95.70%	95.40%	95.10%	94.90%	94.70%	94.50%	94.30%	94.10%	93.90%	93.80%	93.70%	93.60%
MTTFd	100											
CFF	80%											

LS4ER/40-***_L	015	030	045	060	075	090	105	120	135	150
height	160	310	460	610	760	910	1,060	1,210	1,360	1,510
number of beams	6	11	16	21	26	31	36	41	46	51
response time (ms)	3	3,5	4	4.5	5	6	6.5	7	7.5	8
response time Master + Slave (ms)	Ttot = [0.06 * (Nr Slave1 + Nr Master) + 0.9636] * 2 (Master + 1 Slave)									
response time Master + 2 Slave (ms)	Ttot = [0.06 * (Nr Slave1 + Nr Slave2 + Nr Master) + 1.0036] * 2 (Master + 2 Slave)									
Type ⁽¹⁾	4									
SIL ⁽²⁾	3									
SILCL ⁽³⁾	3									
PL ⁽⁴⁾	e									
PFHd	8.84E-09	9.85E-09	1.06E-09	1.16E-09	1.23E-08	1.34E-08	1.41E-08	1.51E-08	1.59E-08	1.69E-08
DCavg	95.80%	95.50%	95.30%	95.10%	95.00%	94.80%	94.70%	94.50%	94.40%	94.20%
MTTFd	100									
CFF	80%									

⁽¹⁾ref. CEI EN 61496-1; CEI EN 61496-2 ⁽²⁾ref. CEI EN 61508 ⁽³⁾ref. CEI EN 62061 + CEI EN 62061/EC2 ⁽⁴⁾ref. UNI EN ISO 13849-1

safety parameters

Light Curtains
Type 4

LS4ER/50-***_L	015	030	045	060	075	090	105	120	135	150
height (mm)	160	310	460	610	760	910	1,060	1,210	1,360	1,510
number of beams	4	8	12	16	20	24	28	32	36	40
response time (ms)	2.5	3	3.5	4	4.5	5	5.5	6	6.5	7
response time Master + Slave (ms)	$T_{tot} = [0.06 * (Nr\ Slave1 + Nr\ Master) + 0.9636] * 2$ (Master + 1 Slave)									
response time Master + 2 Slave (ms)	$T_{tot} = [0.06 * (Nr\ Slave1 + Nr\ Slave2 + Nr\ Master) + 1.0036] * 2$ (Master + 2 Slave)									
Type ⁽¹⁾	4									
SIL ⁽²⁾	3									
SILCL ⁽³⁾	3									
PL ⁽⁴⁾	e									
PFHd	8.50E-09	9.11E-09	9.82E-09	1.4E-09	1.11E-08	1.18E-08	1.25E-08	1.31E-08	1.38E-08	1.44E-08
DCavg	95.90%	95.70%	95.50%	95.40%	95.20%	95.10%	94.90%	94.80%	94.70%	94.60%
MTTFd	100									
CFF	80%									

LS4ER/90-***_L	030	045	060	075	090	105	120	135	150	
height (mm)	310	460	610	760	910	1,060	1,210	1,360	1,510	
number of beams	4	6	8	10	12	14	16	18	20	
response time (ms)	2.5	3	3	3.5	3.5	3.5	4	4	4.5	
response time Master + Slave (ms)	$T_{tot} = [0.06 * (Nr\ Slave1 + Nr\ Master) + 0.9636] * 2$ (Master + 1 Slave)									
response time Master + 2 Slave (ms)	$T_{tot} = [0.06 * (Nr\ Slave1 + Nr\ Slave2 + Nr\ Master) + 1.0036] * 2$ (Master + 2 Slave)									
Type ⁽¹⁾	4									
SIL ⁽²⁾	3									
SILCL ⁽³⁾	3									
PL ⁽⁴⁾	e									
PFHd	8.71E-09	9.23E-09	9.64E-09	1.02E-09	1.06E-08	1.11E-08	1.20E-08	1.31E-08	1.24E-08	
DCavg	95.80%	95.70%	95.60%	95.40%	95.30%	95.10%	95.00%	94.80%	95.00%	
MTTFd	100									
CFF	80%									

LS4ER/**-***_L	0A-050		0B-080		0C-090	
height (mm)	500		800		900	
number of beams	2		3		4	
response time (ms)	2.5		2.5		2.5	
response time Master + Slave (ms)	$T_{tot} = [0.06 * (Nr\ Slave1 + Nr\ Master) + 0.9636] * 2$ (Master + 1 Slave)					
response time Master + 2 Slave (ms)	$T_{tot} = [0.06 * (Nr\ Slave1 + Nr\ Slave2 + Nr\ Master) + 1.0036] * 2$ (Master + 2 Slave)					
Type ⁽¹⁾	4					
SIL ⁽²⁾	3					
SILCL ⁽³⁾	3					
PL ⁽⁴⁾	e					
PFHd	9.15E-09		9.99E-09		1.08E-08	
DCavg	95.80%		95.60%		95.40%	
MTTFd	100					
CFF	80%					

⁽¹⁾ref. CEI EN 61496-1; CEI EN 61496-2 ⁽²⁾ref. CEI EN 61508 ⁽³⁾ref. CEI EN 62061 + CEI EN 62061/EC2 ⁽⁴⁾ref. UNI EN ISO 13849-1

LS4; LS4_K;
LS4_H

LS4 series receiver

**M12
(8 poles male)**



LS4ER / **-***
LS4ER / **-***M

8 poles male

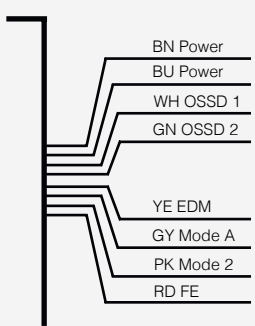

LS4ER / **-***K

pin	color	signal	type	description
1	WH	OSSD1	OUT	first safety static output (PNP)
2	BN	24V _{DC}	POWER	power supply input
3	GN	OSSD2	OUT	second safety static output (PNP)
4	YE	EDM	IN	connection to Restart and/or external control contacts (EDM)
5	GY	Mode_A	IN	selection of the Start/Restart/EDM mode
6	PK	Mode_B	IN	selection of the Start/Restart/EDM mode
7	BU	0V	POWER	supply voltage reference
8	RD	FE	GND	functional earth

possible combinations			
pin4 (YE)	pin5 (GY)	pin6 (RK)	function
24V _{DC}	24V _{DC}	0V	AUTO
K1 + K2 + 24V _{DC}	24V _{DC}	0V	AUTO + EDM
restart + 24V _{DC}	0V	24V _{DC}	MANUAL
K1 + K2 + restart + 24V _{DC}	0V	24V _{DC}	MANUAL + EDM

BK black

BN brown

RD red

YE yellow

WH white

PK pink

OG orange

GN green

BU blue

GY grey

VT violet

NOTE: On these Standard and Master models it is possible to choose the operating modes by changing the wiring. By using the EDM function it is possible to extend the safety control to the contactors controlled downstream, that must be the type with guided contacts and approved for safety applications. With this model of curtain you can use the relay module SB300, but the EDM input must be connected.

**M12
(5 poles male)**



LS4ER / **-***B

pin	color	signal	type	description
1	BN	24V _{DC}	POWER	power supply input
2	WH	OSSD1	OUT	first safety static output (PNP)
3	BU	0V	POWER	supply voltage reference
4	BK	OSSD2	OUT	second safety static output (PNP)
5	GY	FE	GND	functional earth

NOTE: These Base models with automatic restart do not have the EDM function, the device downstream must therefore be able to control its own safety integrity independently. With this model of curtain you can not use the relay module SB300, because the EDM input is not available.

electrical diagrams of the connections

Light Curtains
Type 4

LS4 series receiver

10 poles cable
(IP69K with heater receiver unit)

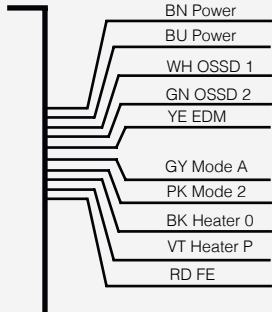

LS4ER / **-***H

color	signal	type	description
BN	24V _{DC}	POWER	power supply input
BU	0v	POWER	supply voltage reference
WH	OSSD1	OUT	first safety static output (PNP)
GN	OSSD2	OUT	second safety static output (PNP)
YE	EDM	IN	connection to restart and/or external control contacts (EDM)
GY	Mode_A	IN	selection of the Start/Restart/EDM mode
PK	Mode_B	IN	selection of the Start/Restart/EDM mode
BK	Heater 0	POWER	heater supply common
PK	Heater p	POWER	heater supply 24V DC or AC
BK	FE	GND	functional earth

possible combinations

YE	GY	PK	function
24V _{DC}	24V _{DC}	0V	AUTO
K1 + K2 + 24V _{DC}	24V _{DC}	0V	AUTO + EDM
restart + 24V _{DC}	0V	24V _{DC}	MANUAL
K1 + K2 + restart + 24V _{DC}	0V	24V _{DC}	MANUAL + EDM
x	0V	0V	NOT ADMITTED
x	24V _{DC}	24V _{DC}	NOT ADMITTED

black orange
brown green
red blue
yellow grey
white violet
pink

NOTE: On these Standard models it is possible to choose the operating modes by changing the wiring. By using the EDM function it is possible to extend the safety control to the contactors controlled downstream, that must be the type with guided contacts and approved for safety applications. The supply voltage of the thermostated heater can be indifferently 24 V_{DC} or 24 V_{AC}. With this model of curtain you can use the relay module SB300, but the EDM input must be connected.

LS4 series emitter unit

M12
(5 poles male connector)



LS4ER / **-***
LS4ER / **-***M

pin	color	signal	type	description
1	BN	POWER	OUT	power supply input
2	WH	IN	POWER	range or test selection input
3	BU	POWER	OUT	supply voltage reference
4	BK	IN	IN	range or test selection input
5	GY	IN	IN	functional earth

possible combinations

pin2 (WH)	pin6 (BK)	function
LO	LO	test
LO	HI	high range
HI	LO	low range
HI	HI	NOT ADMITTED

Levels: LO = < 5V or open; HI = 11 to 30V

black orange
brown green
red blue
yellow grey
white violet
pink

5 poles cable

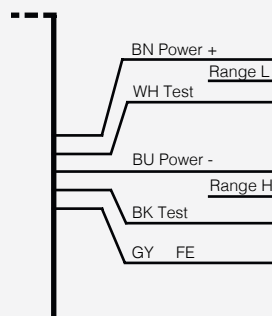

LS4ER / **-***K

NOTE: The Test contact is necessary only if the safety chain of the receiver downstream must be periodically checked. If the Test is not necessary (the safety light curtain has already been tested independently) replace the contact with direct wiring at +24 V_{DC}.

LS4; LS4_K;
LS4_H

LS4 series IP69K with heater Emitter unit

8 poles cable
(IP69K with heater emitter unit)

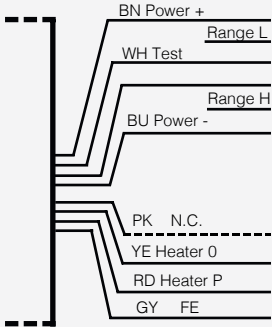

LS4ER / **-****H

color	signal	type	description
BN	24 _{CC}	POWER	power supply input
WH	Range L/Test	IN	range or test selection input
BU	0V	POWER	supply voltage reference
GN	Range H/Test	IN	range or test selection input
PK	not connected	N.C.	not connected
YE	heater 0	POWER	heater supply common
RD	heater P	POWER	heater supply 24V DC or AC
GY	FE	GND	functional earth

possible combinations

WH	GN	function
LO	LO	test
LO	HI	high range
HI	LO	low range
HI	HI	not admitted

levels: LO = <5V or open; HI = 11 to 30V

BK black	OG orange
BN brown	GN green
RD red	BU blue
YE yellow	GY grey
WH white	VT violet
PK pink	

NOTE The Test contact is necessary only if the safety chain of the receiver downstream must be periodically checked. If the Test is not necessary (the safety light curtain has already been tested independently) replace the contact with direct wiring at +24VDC. The supply voltage of the thermostated heater can be indifferently 24 V_{DC} or 24 V_{AC}. The PK cable is not connected internally

LS4 series emitter and receiver unit : master slave secondary connectors

M12
(5 poles male)



LS4ER / **-****M
LS4ER / **-****S
LS4ER / **-****F

pin	color	signal	type	description
1	BN	24V _{CC}	POWER	power supply (supply line for the upstream device)
2	WH	Line 1	IN/OUT	communication line 1
3	BU	0V	POWER	power supply reference (supply line for the upstream device)
4	BK	Line 2	IN/OUT	communication line 2
5	GY	FE	GND	functional earth

NOTE: Preferably use Female/Female pre-wired extension cables (it is not permitted to access the connection lines).

dimensions (mm)

dimensions of Standard, Base, Final models; view of the base and head with relevant connectors; see Tab.: 1 and 3

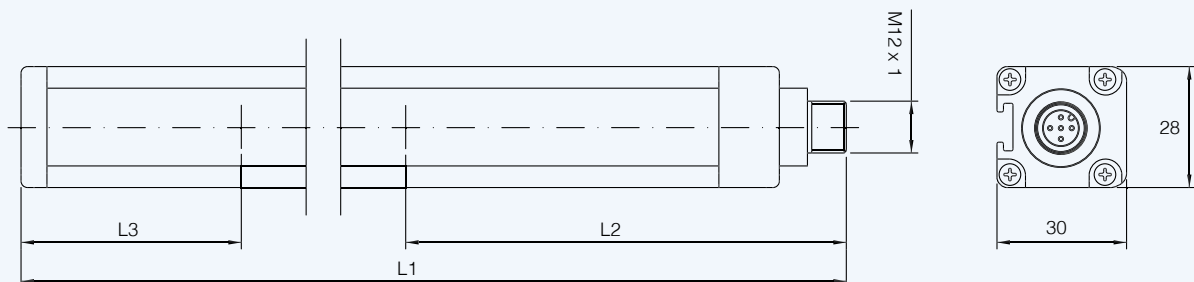

dimensions (mm)

Dimensions of Master and Slave models; view of the base and head with relevant connectors; see Tab.: 2 and 3

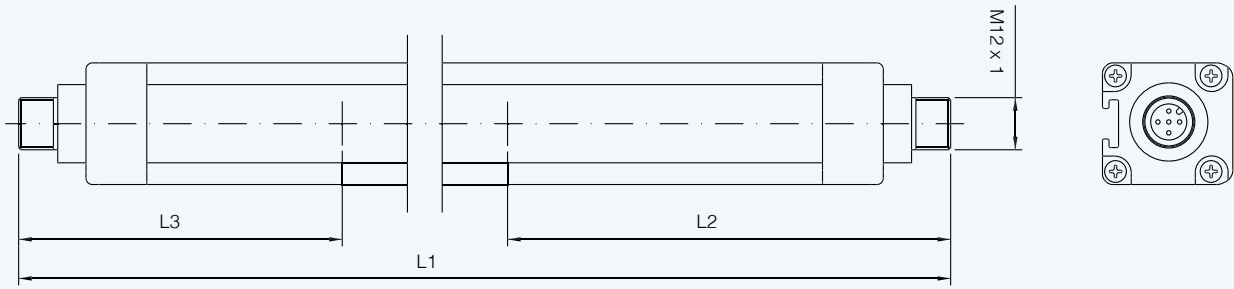

TAB.1

LS4 series		***										dimensions (mm)
paired models		015	030	045	060	075	090	105	120	135	150	L1
LS4ER/**-*** LS4ER/**-***B LS4ER/**-***F	standard, base, final	213	363	513	663	813	963	1,113	1,263	1,413	1,563	L2 (bottom-most beam)
		61,5										L3 (top-most beam)
		11										L4
LS4ER/**-***M LS4ER/**-***S	master and slave	236.5	386.5	536.5	686.5	836.5	986.5	1,136.5	1,286.5	1,436.5	1,586.5	L5 (bottom-most beam)
		61.5										L6 (top-most beam)
		34.5										



TAB.2

LS4 series		***			dimensions (mm)
paired models		0A-050	0B-080	0C-090	
LS4ER/**-*** LS4ER/**-***B LS4ER/**-***F	standard, base, final	653	953	1,053	L1
		102			L2 (bottom-most beam)
		51			L3 (top-most beam)
LS4ER/**-***M LS4ER/**-***S	master and slave	677	977	1,077	L4
		102			L5 (bottom-most beam)
		75			L6 (top-most beam)

TAB.3

LS4 series		LS4R (receiver)				LS4R (emitter)			
models		base view	connector	base view	connector	base view	connector	base view	connector
LS4ER/**-***	standard	C	M12, 8p, M	A	-	B	M12, 5p, M	A	-
LS4ER/**-***B	base	B	M12, 5p, M	A	-	B	M12, 5p, M	A	-
LS4ER/**-***F	final	B ⁽¹⁾	M12, 5p, M	A	-	B ⁽¹⁾	M12, 5p, M	A	-
LS4ER/**-***M	master	F	M12, 8p, M	D ⁽¹⁾	M12, 5p, M	E	M12, 5p, M	D ⁽¹⁾	M12, 5p, M
LS4ER/**-***S	slave	E ⁽¹⁾	M12, 5p, M	D ⁽¹⁾	M12, 5p, M	E ⁽¹⁾	M12, 5p, M	D ⁽¹⁾	M12, 5p, M

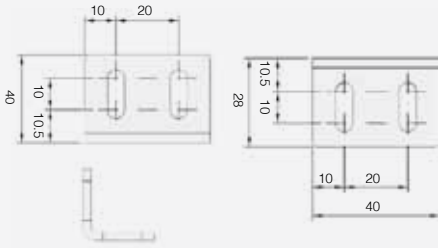
NOTE: These connectors are dedicated to a communication BUS of the Master/ Slave chain, it is not permissible to access the lines, always use cord sets.

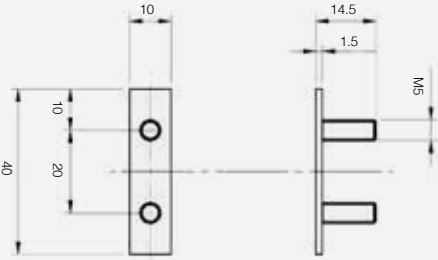
ST204* / outfit mounting accessories			
product	to used with	dimensions (mm)	description / installation
	LS4 series		<p>L Bracket</p> <p>Supplied as standard, 4 pieces to couple to the length from 300 to 1,050, 6 pieces for the length from 1,200 to 1,500.</p>
	LS4 series		<p>Insert with threaded bolts and nuts</p> <p>Supplied as standard, in a number corresponding to the brackets.</p>

outfit brackets mounting

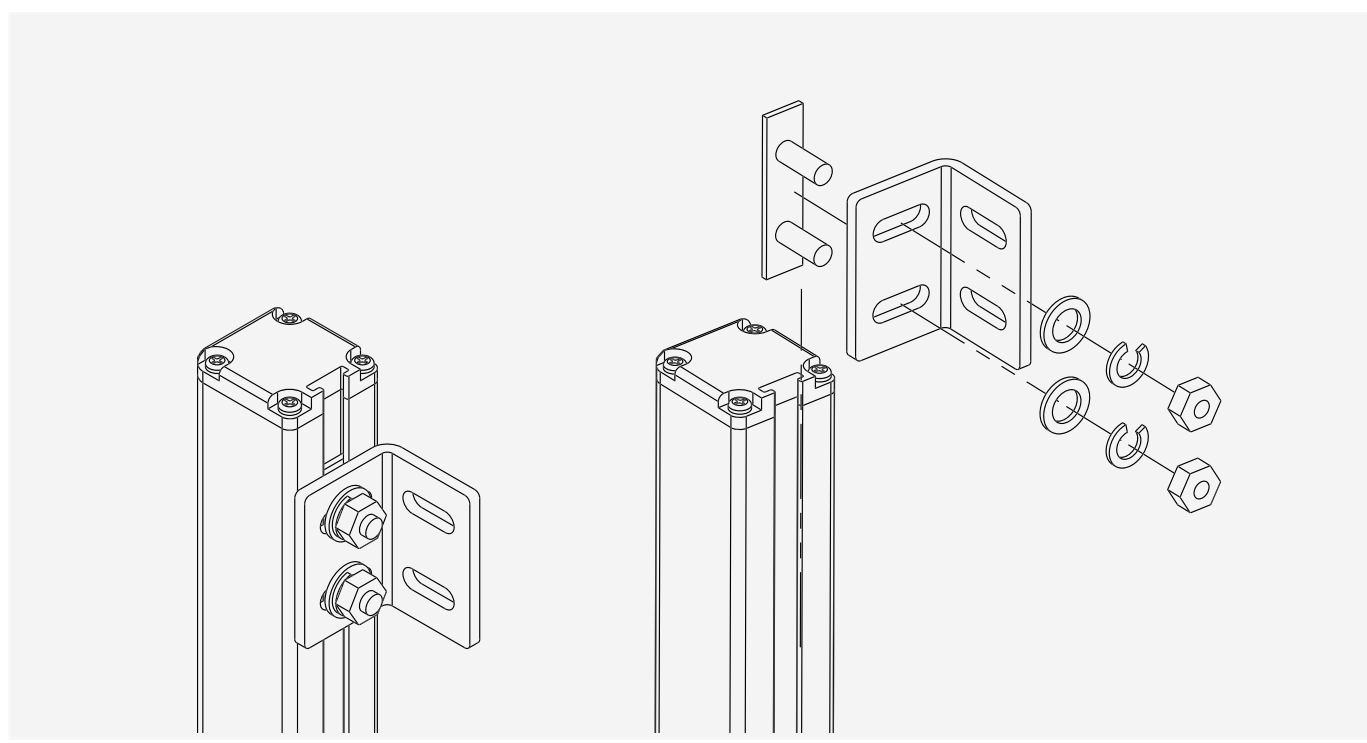

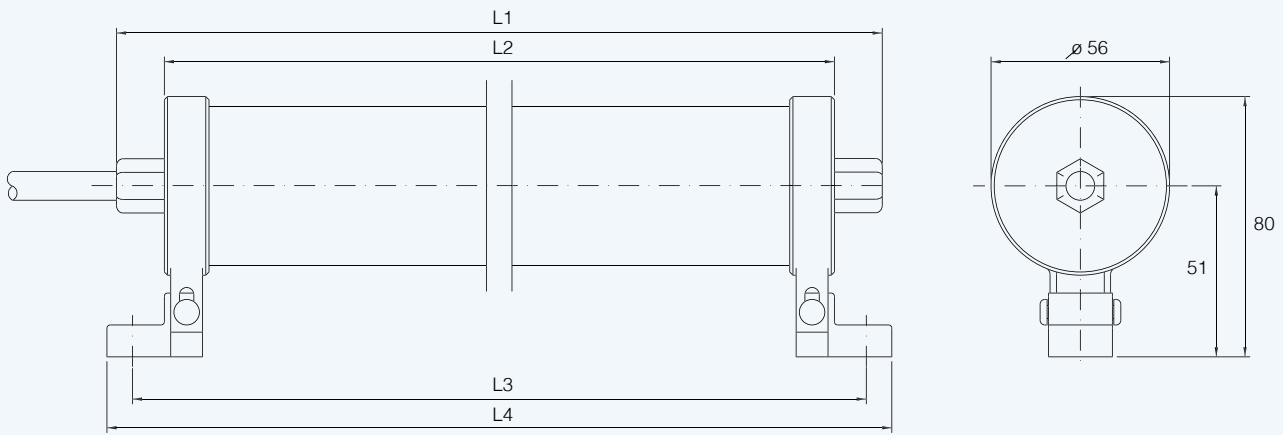

The light Curtain is supplied already fitted inside the transparent housing.
The power cord has a standard length of 10 meters and a maximum diameter of 6 mm. The brackets are included.

models	150	300	450	600	750	900	1,050	1,200	1,350	1,500	2B	3B	4B
L1 dimensions	320	470	620	770	920	1,070	1,220	1,370	1,520	1,670	760	1,060	1,160
L2 dimensions	290	440	620	740	890	1,040	1,190	1,340	1,490	1,640	730	1,030	1,130
L3 dimensions (± 3) (mm)	315	465	590	765	915	1,065	1,215	1,365	1,515	1,665	755	1,055	1,155
L4 dimensions (mm)	337	487	637	787	937	1,087	1,237	1,387	1,537	1,687	777	1,077	1,177