

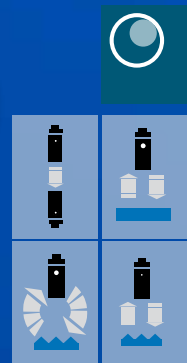

QX series

DC miniaturized cubic photoelectric sensors



DC miniaturized cubic

features

- Axial and right angle optics
- 2 LEDs (threshold and signal margin)
- Visible red light in retro-reflective, polarized and through-beam models
- Long distances capability
- Precision beam
- Fast response time (0,75-0,5 ms)
- NPN-PNP selectable output
- High output current (>300 mA)

web content



- Application notes
- Photos
- Catalogue / Manuals



code description

QX 3 / A 0 - 1 A

series	QX	Miniaturized photoelectric sensor
type	3	Diffuse reflection 300 mm
	C	Retro-reflective 5 m
	P	Polarized 3 m
	X	Emitter with check
	R	Receiver 8 m
output	A	NO output state
	C	NC output state
	0	Emitter
axial / radial optics	1	Axial optics
	2	Right angle optics
cable / plug output	A	Cable exit 2 m
	F	M8 plug cable exit
	E	M12 plug cable exit

available models

axial optic

model	distance	cable		plug M8		plug M12	
		NO	NC	NO	NC	NO	NC
direct diffuse	300 mm	QX3/A0-1A	QX3/C0-1A	QX3/A0-1F	QX3/C0-1F	QX3/A0-1E	QX3/C0-1E
retro-reflective	5 m	QXC/A0-1A	QXC/C0-1A	QXC/A0-1F	QXC/C0-1F	QXC/A0-1E	QXC/C0-1E
polarized	3 m	QXP/A0-1A	QXC/C0-1A	QXP/A0-1F	QXP/C0-1F	QXP/A0-1E	QXP/C0-1E
through-beam	8 m	QXX/00-1A		QXX/00-1F		QXX/00-1E	
		emitter	QXR/A0-1A	QXR/C0-1A	QXR/A0-1F	QXR/C0-1F	QXR/A0-1E
receiver							

QX





DC miniaturized cubic

available models

radial optic

model	distance	cable		plug M8		plug M12	
		NO	NC	NO	NC	NO	NC
direct diffuse	300 mm	QX3/A0-2A	QX3/C0-2A	QX3/A0-2F	QX3/C0-2F	QX3/A0-2E	QX3/C0-2E
retro-reflective	5 m	QXC/A0-2A	QXC/C0-2A	QXC/A0-2F	QXC/C0-2F	QXC/A0-2E	QXC/C0-2E
polarized	3 m	QXP/A0-2A	QXC/C0-2A	QXP/A0-2F	QXP/C0-2F	QXP/A0-2E	QXP/C0-2E
through-beam	emitter receiver	QXX/00-2A		QXX/00-2F		QXX/00-2E	
		QXR/A0-2A	QXR/C0-2A	QXR/A0-2F	QXR/C0-2F	QXR/A0-2E	QXR/C0-2E

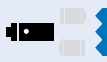
technical specification

	diffuse reflection	retro-reflective	polarized	through-beam
	QX3/*0-**	QXC/*0-**	QXP/*0-**	QXX/*0-** QXR/*0-**
				
nominal sensing distance	300 mm ⁽¹⁾	5 m ⁽²⁾	3 m ⁽²⁾	8 m
emission	infrared (880 nm)	red (660 nm)		
minimum detectable object	see characteristic curves			2 mm
tolerance	+ 15 % / - 5 % Sn			-
hysteresis	10 %			
repeatability	5 %			
operating voltage	10,8...30 Vdc			
ripple	10 % max			
load current	20 mA max			20 mA (emitter) 5 mA (receiver)
check voltage	-			10,8...30 Vdc (QXX)
load current	300 mA			
leakage current	100 µA max at 30 Vdc			
output voltage drop	1,2 V max IL = 100 mA			
output type	PNP or NPN selectable			
switching frequency	750 Hz (Tr = 0,5 ms)			500 Hz (Tr = 0,75 ms)
power on delay	200 ms			
operating temperature range	- 25°C...+ 70°C (without freeze)			
power supply protections	polarity reversal, transient			
output protection	short circuit (autoreset)			
protection degree	IP67 (EN60529) ⁽³⁾			
EMC	in conformity with the EMC Directive according to EN 60947-5-2			
external light interference	3,000 lux (incandescent lamp), 10,000 lux (sunlight)			
LEDs	RED LED (margin low signal) CHECK (QXX) GREEN LED (stability) POWER (QXX)			
housing material	ABS (glass fiber reinforced)			
optic material	acrylic			
weight (approximate)	30 g connector / 70 g cable (single)			

⁽¹⁾ With 100x100 mm white matt paper ⁽²⁾ With standard reflector Ø80 mm (RL110 supplied separately) ⁽³⁾ Protection guaranteed only with plug cable well mounted

electrical diagrams of the connections

emitter with check

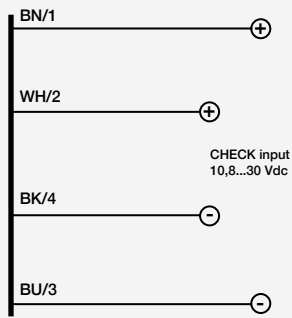

NPN output

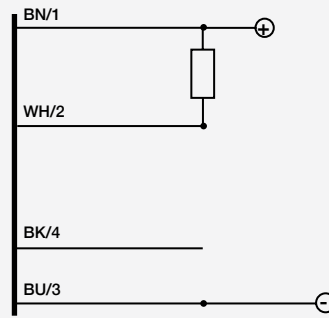

PNP output

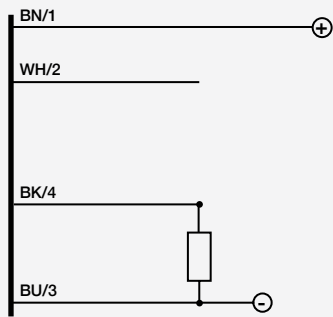

- BN** brown
- BU** blue
- BK** black
- WH** white

plug

M8

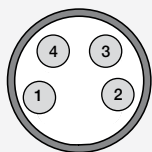

M12

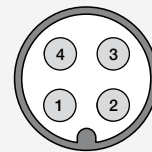



response diagrams

direct reflection models

DC miniaturized cubic

QX3/*0-** excess gain

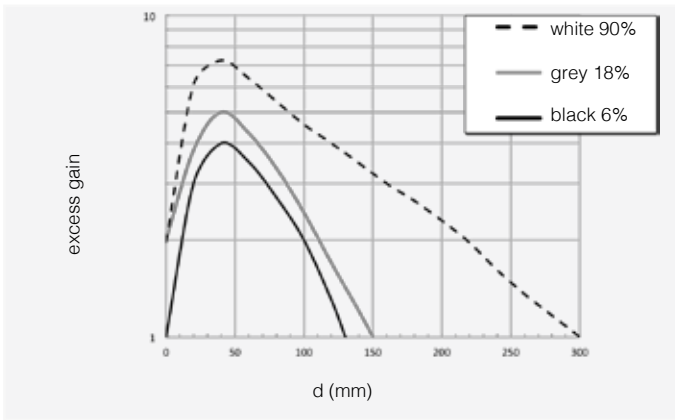

QX3/*0-** spot dimension

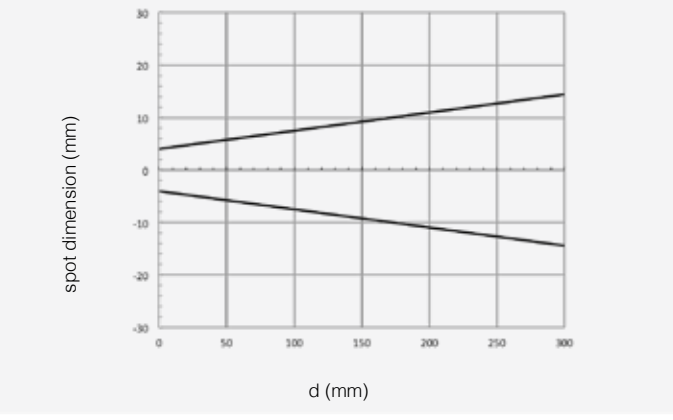

QX3/*0-** parallel displacement

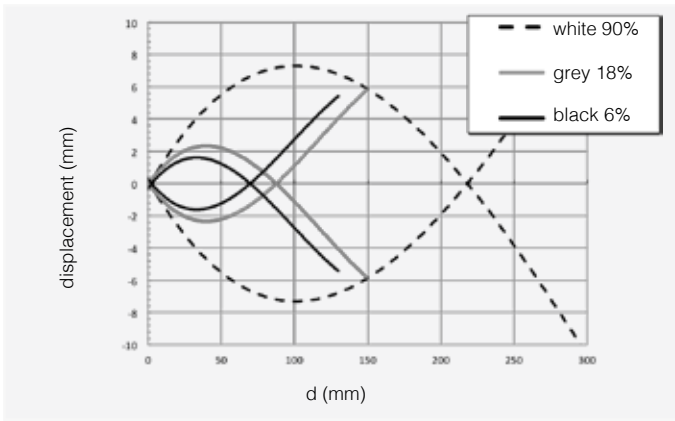

response diagrams

retroreflective models

QXC/*0-** excess gain

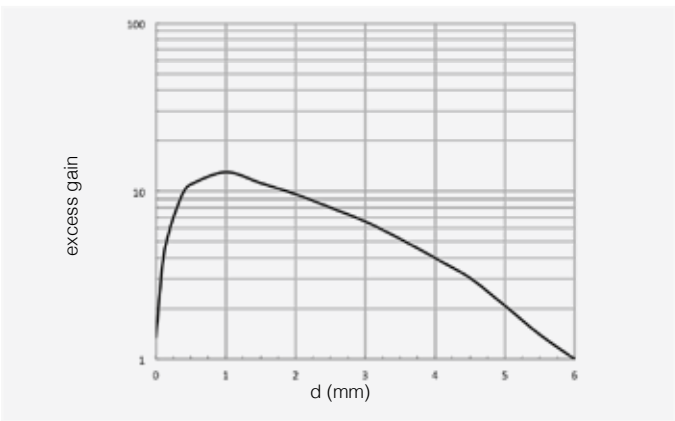

QXC/*0-** spot dimension

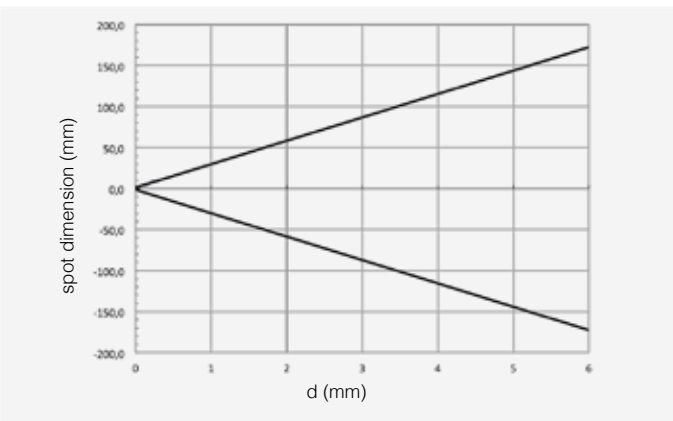

QX



QXC/*0-** parallel displacement

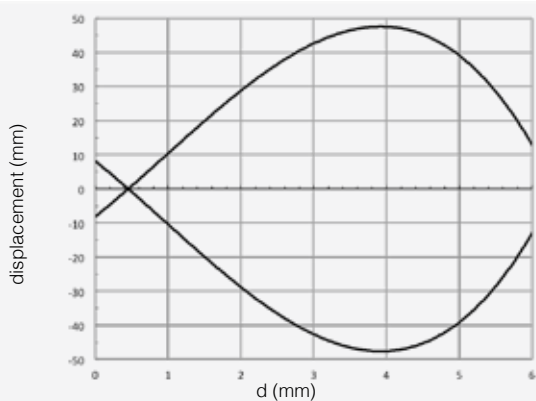

response diagrams

polarized models

QXP/*0-** excess gain

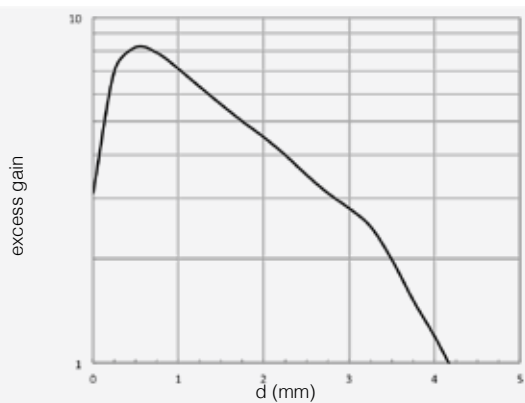

QXP/*0-** spot dimension

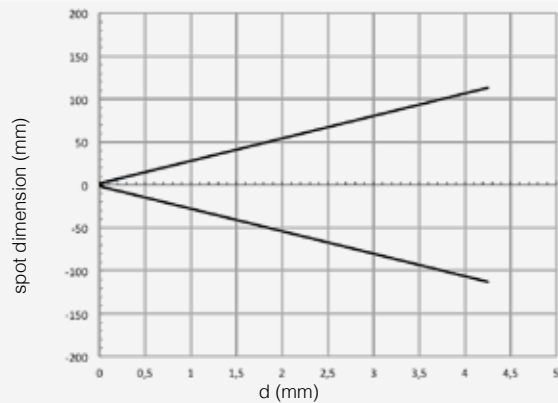

QXP/*0-** parallel displacement

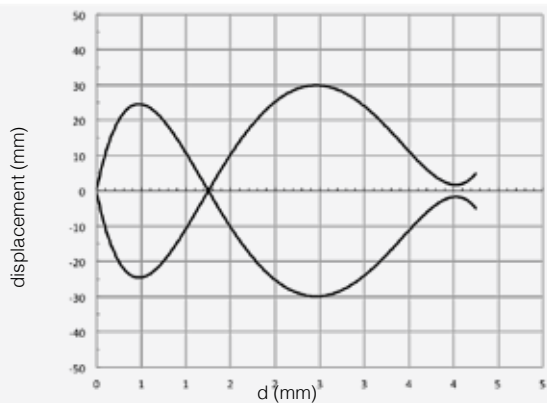



response diagrams

through-beam

DC miniaturized
cubic

QXX/00-**- QXR/*0-** excess gain

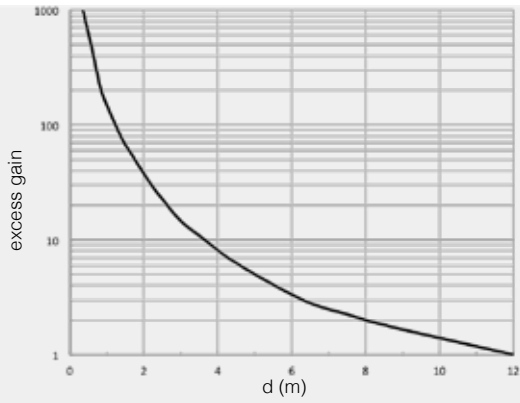

QXX/00-**- QXR/*0-** spot dimension

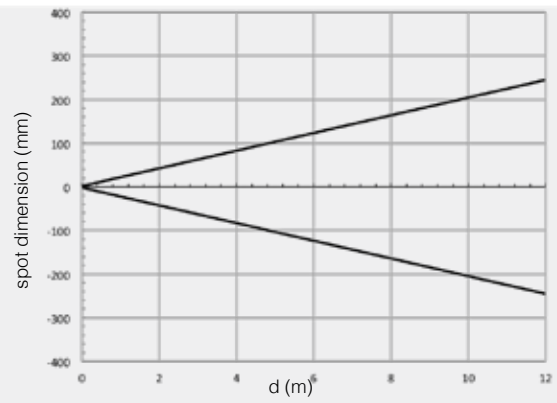

QXX/00-**- QXR/*0-** parallel displacement

