



PE6 series

M8 cylindrical
miniaturized inductive sensors



M8 cylindrical
miniaturized

features

- Cable and M8 plug versions
- Extremely reduced dimensions: M8 x 16 mm (cable) /29 mm (plug) length
- Supply voltage 10...30 Vdc, output current 200 mA
- Led status indicator
- P 67 housing protection
- Complete protection against electrical damages



web contents



- Application notes
- Photos
- Catalogue / Manuals



code description

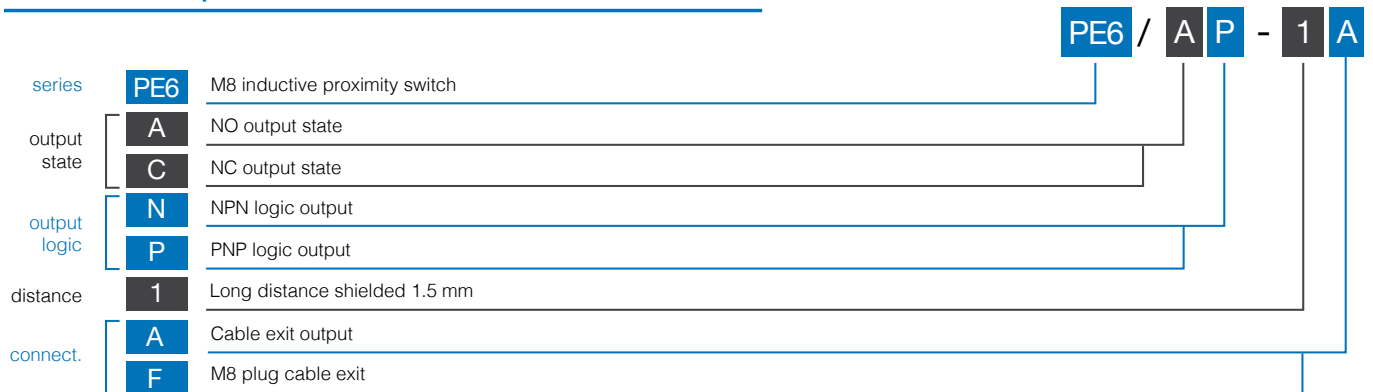

available models

model	installation	sensing	plug	distance (mm)	NPN/NO	NPN/NC	PNP/NO	PNP/NC
M8	shielded	standard	cable	1.5	PE6/AN-1A	PE6/CN-1A	PE6/AP-1A	PE6/CP-1A
			M8		PE6/AN-1F	PE6/CN-1F	PE6/AP-1F	PE6/CP-1F

PE6/**-1*	
	
nominal sensing distance	≤ 1.5 mm
hysteresis	≤ 10% Sr
standard target	8 x 8 x 1 mm
repeatability	2%
operating voltage	10...30 Vdc
max ripple content	≤ 20%
output type	NPN or PNP - NO or NC
output current	≤ 200 mA
output voltage drop	≤ 2.0 V @ 100 mA
no-load supply current	≤ 10 mA
leakage current	≤ 0.1 mA
switching frequency	≤ 5,000 Hz
power on delay	10 ms
ambient temperature range	-25...+70 °C
temperature drift of Sr	≤ 10%
short-circuit protection	•
voltage reversal protection	•
induction protection	•
shocks and vibration	IEC 60947-5-2 / 7.4
weight	10 g connector M8 40 g cable
protection degree	IP 67
EMC:	
IEC 60255-5	1 kV
IEC 61000-4-2	level 2
IEC 61000-4-3	level 3
IEC 61000-4-4	level 2
housing material	stainless steel V2A
active head material	polyester
connection	2 m PVC cable 3 x 0.14 mm ²

correction factors

model	steel FE 360	copper	alluminium	brass	stainless steel
PE6/**-1*	1.0	0.40	0.45	0.50	0.80

electrical diagrams of connections

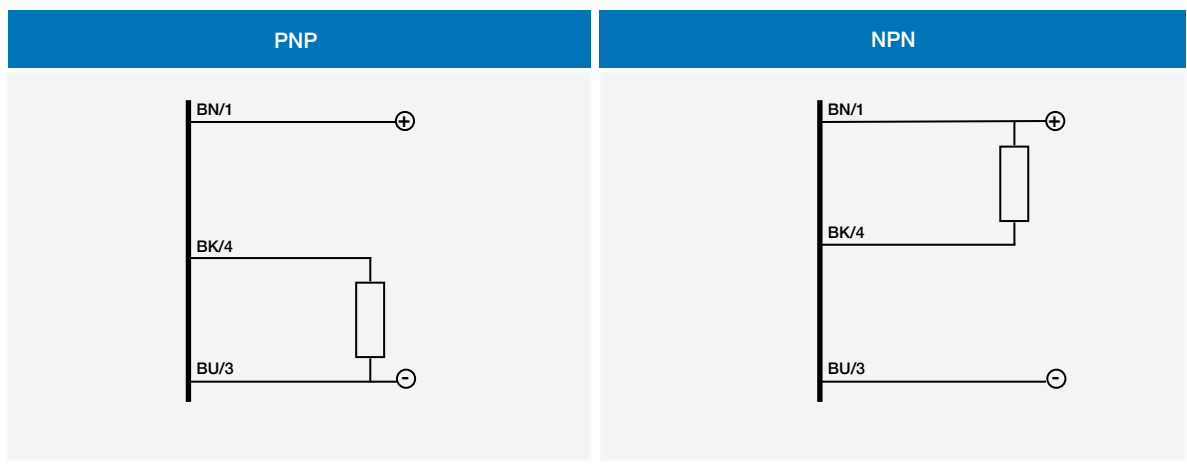

- BN** brown
- BU** blue
- BK** black
- WH** white

M8 cylindrical miniaturized

plug

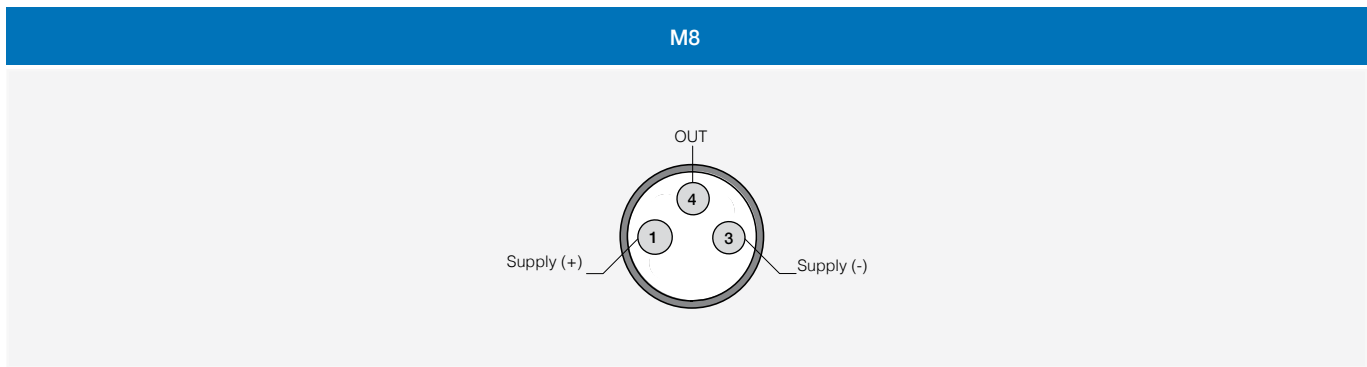

response diagram

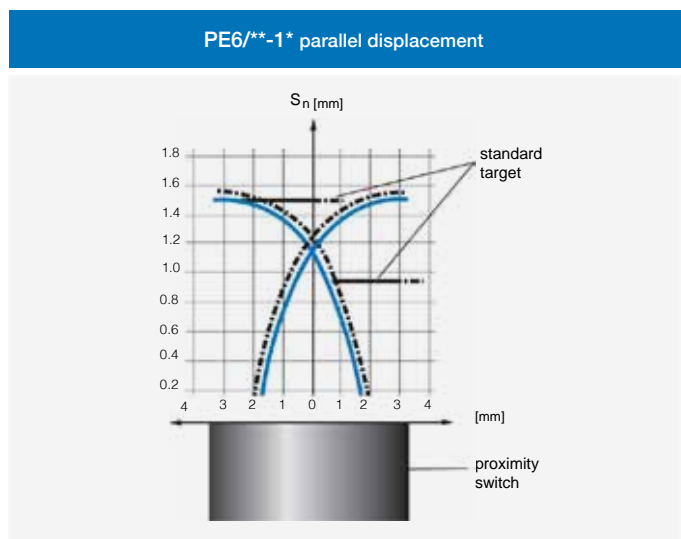

installation

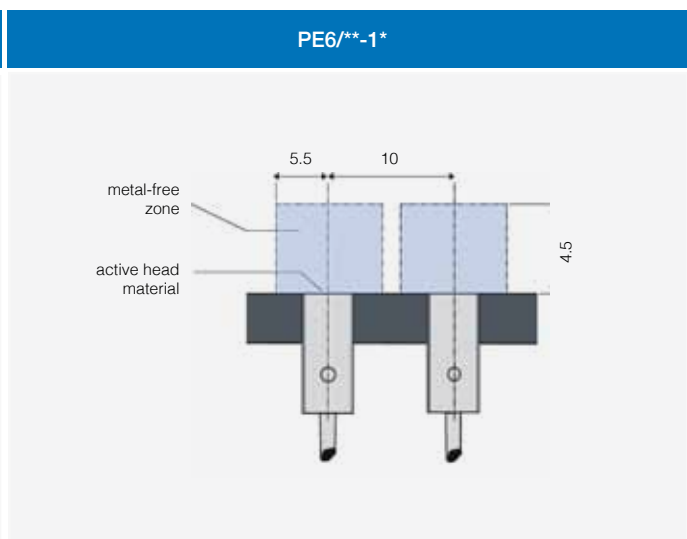



dimensions (mm)

M8 cylindrical
miniaturized

PE6/**-1A	PE6/**-1F

1 LED

dimensions (mm)

accessories included models

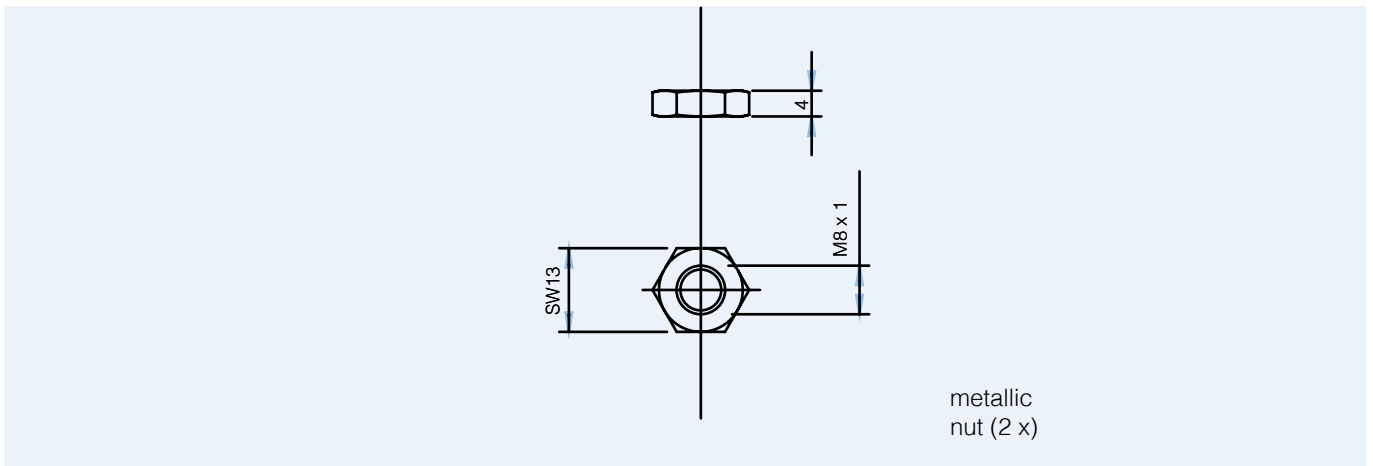

PE6